



***Python***

***KP52-54*** Mark I

***KP102-54*** Mark I

USER GUIDE  
English



## TABLE OF CONTENTS

SYMBOLS .....	3
1. INTRODUCTION .....	4
2. KEY FEATURES .....	4
3. SAFETY INFORMATION .....	5
4. UNPACKING .....	6
5. PHYSICAL .....	6
5.1 KP52-54 I LAYOUT .....	6
5.2 KP102-54 I LAYOUT .....	7
6. WIRING .....	8
6.1 IMPEDANCE SWITCH .....	8
6.2 COVERAGE SWITCH .....	9
7. HANGING ON THE WALL .....	10
8. SERVICE .....	11
9. TECHNICAL SPECIFICATIONS .....	12
10. EN54-24 DATA .....	13

## SYMBOLS



K-array declares that this device is in compliance with applicable CE standards and regulations. Before putting the device into operation, please observe the respective country-specific regulations!



Waste Electrical and Electronic Equipment (WEEE)  
Please dispose of this product at the end of its operational lifetime by bringing it to your local collection point or recycling center for such equipment.



This symbol alerts the user to the presence of recommendations about the product's use and maintenance.



Warning: DANGEROUS VOLTAGE.  
Terminals marked with this symbol carry a risk of electric shock, therefore external wiring connected to these terminals requires installation by a qualified professional or the use of ready-made leads or cords.



This symbol alerts the user to the presence of recommendations about product's use and maintenance.



This device complies with the Restriction of Hazardous Substances Directive.

## 1. INTRODUCTION

The K-array KP52-54 I and KP102-54 I are specifically designed to be included in voice alarm systems.

The K-array Pythons are passive speaker systems, comprised of 3.15" neodymium magnet transducers housed in an elegant and sturdy stainless steel chassis. Available in two lengths, the KP52-54 I features 6 drivers in a 0.5 m (20") chassis, while the KP102-54 I features 12 drivers in a 1 m (40") chassis.

The Pythons's closely spaced cone drivers provide phase coherence, low distortion and focused listening both up close and at a distance.

To accommodate a range of applications, the vertical dispersion pattern can be switched for either wide or narrow coverage.

For integration with other speakers or amplifiers, the KP52-54 I and KP102-54 I offer selectable impedance (8Ω/32Ω for the KP52-54 I and 4Ω/16Ω for the KP102-54 I).

Pythons are able to reproduce the entire vocal frequency range with excellent intelligibility, starting from 100 Hz.

Integrating powered K-array subwoofers (KMT12, KMT18, KMT21, KMT218) ensures excellent coverage of the entire musical frequency range. K-array's KA amplifier series also features custom presets, optimized for use with the Python series.

All Python components are designed by K-array and custom-made under K-array's quality control system.

## 2. KEY FEATURES

- EN54-24 compliant
- Unique performance-to-size ratio
- Vertical and Horizontal applications
- Multiple 3.15" long-excursion full-range cone drivers
- Wide horizontal coverage
- Selectable vertical pattern (Spot/Flood)
- Electronically protected
- Selectable impedance (KP52-54 I: 8/32 Ω, KP102-54 I: 4/16 Ω)
- Weather proof, suitable for outdoor installations - IP54
- Available in black or white

### 3. SAFETY INFORMATION



Warning: failure to follow these safety instructions could result in injury or damage to the device or other property.

#### IMPORTANT SAFETY INSTRUCTIONS

- Read these instructions.
  - Keep this instructions.
  - Heed all warnings.
  - Follow all instructions and keep all warnings.
  - Only use attachments/accessories specified by the manufacturer.
- 

  - Use only with the cart, stand, tripod, bracket, or table specified by the manufacturer or sold with the apparatus.
  - When a cart is used, use caution when moving the cart/apparatus combination to avoid injury from tip-over.
- **Avoiding hearing damage.** Professional loudspeakers are capable of producing extremely high sound levels and should be used carefully. Never stand close to loudspeakers driven at high volume. Set the volume to a safe level. You can adapt over time to a higher volume of sound that over time may sound normal but can be damaging to your hearing. Hearing loss worsens after exposure to a sound level of 90 dB or over for an extended period of time. If you experience ringing in your ears or muffled speech, stop listening and have your hearing checked. The louder the volume, the less time is required before your hearing could be affected.
  - **Choking Hazards.** This device contains small parts, which may present a choking hazard to small children. Keep the device and its accessories away from small children.
  - **Do not make repairs yourself.** Never attempt to disassemble, repair or modify the system yourself. Disassembling the unit may cause damage that is not covered under the warranty. The device contains no user-serviceable parts. Repairs should only be performed by factory trained service personnel.
  - **Sound distortion.** Do not operate speakers for an extended period of time with sound distortion. This is an indication of malfunction, which in turn can generate heat and result in a fire.
  - **Carrying, handling and installing the device.** The device contains sensitive components. Do not drop, disassemble, open, crush, bend, deform, puncture, shred, incinerate, paint, or insert foreign objects into it. If your device has been dropped or damaged unplug the power cable immediately.
  - **Set up.** Set up your device on a stable retaining horizontal surface. If combined or mechanically connected with other products, always verify the stability of the resulted system. Install the unit only in a location that can structurally support the weight of the unit and far away from people who can interfere with the stability of the system. Assure that the wind does not interfere with the system's stability, taking extra securities like chains, weights, ropes or any other certified anchoring systems. Doing otherwise may result in the unit falling down, causing personal injury or property damage or even death. The system should only be suspended by qualified personnel following safe rigging practices. Secure fixings to the building structure are vital. To clarify any doubt you may have, seek help from architects, structural engineers or other specialists.

## 4. UNPACKING

Each K-array speaker is built to the highest standard and thoroughly inspected before leaving the factory. Upon arrival, carefully inspect the shipping carton, then examine and test your new amplifier. If you find any damage, immediately notify the shipping company. Only the consignee may institute a claim procedure regarding the system's electronic equipment.

## 5. PHYSICAL

### 5.1 KP52-54 I LAYOUT

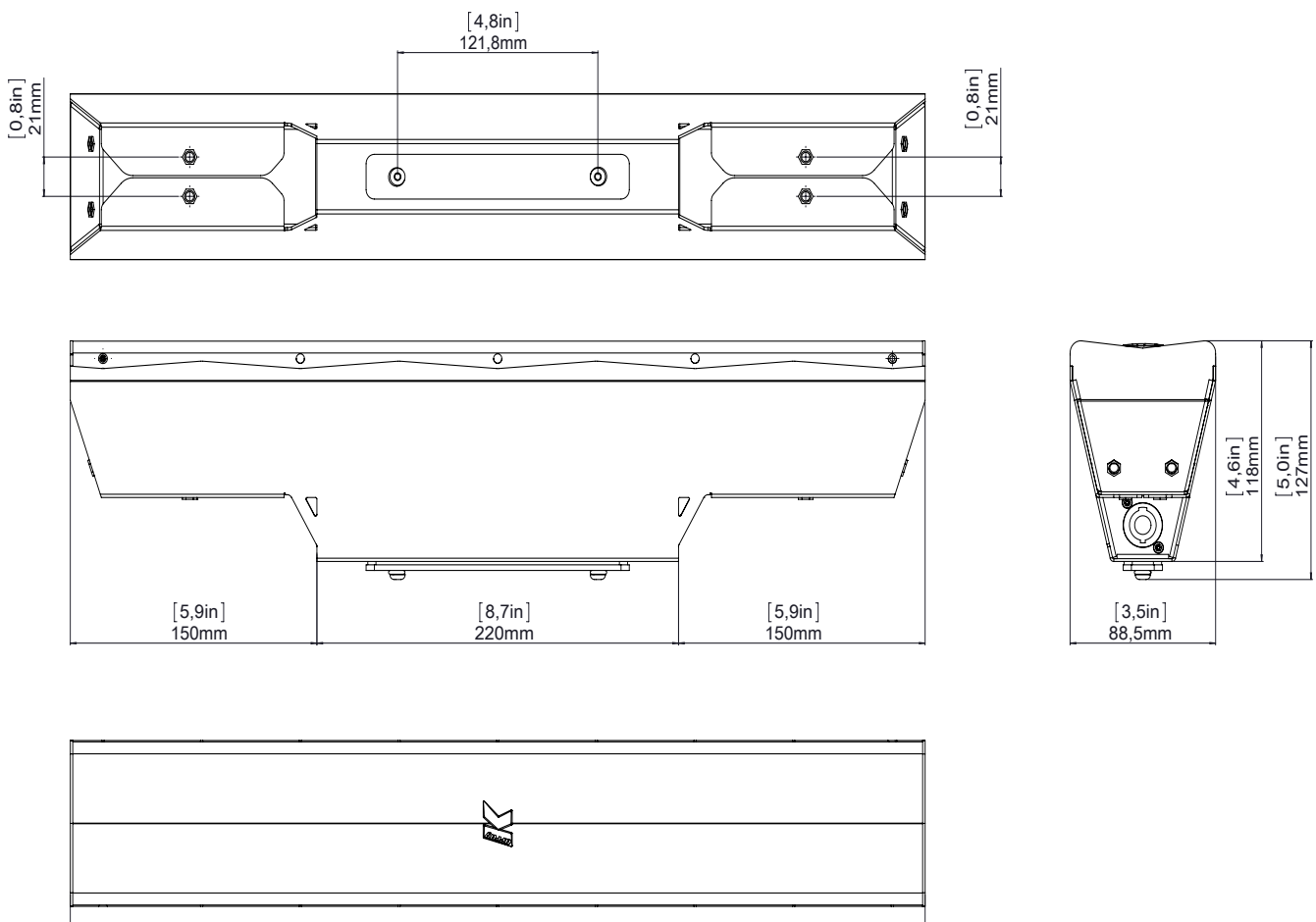

Weight  
5.8 kg (12.8 lbs)

### 5.2 KP102-54 I LAYOUT

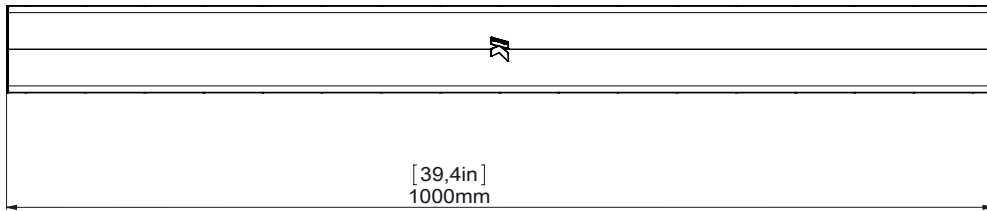
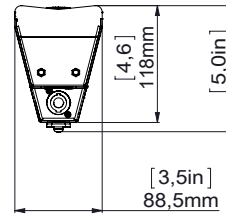
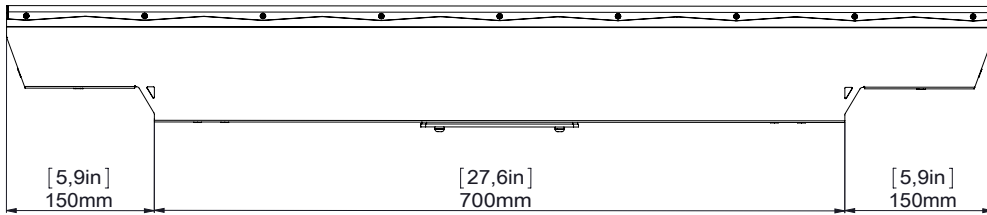
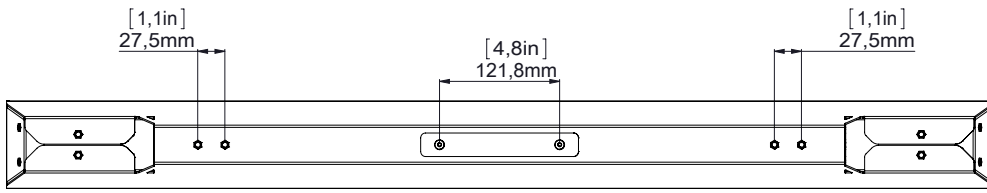

Weight  
12 kg (26.5 lbs)

## 6. WIRING

KP52-54 I and KP102-54 I feature a 2x2.5 cable coming out from the chassis, ready to be connected to the cable coming from the amplifier.



### 6.1 IMPEDANCE SWITCH

KP52-54 I and KP102-54 I feature a switch which allows users to select the impedance of the speaker (KP52-54 I: 8/32 Ω, KP102-54 I: 4/16 Ω).

The value to be selected depends mainly on the amplifier you use to drive the unit. Impedance must be set to high (32 Ω for KP52-54 I and 16 Ω for KP102-54 I) when speakers are driven by KMT active modules or by the KA84 amplifier. Low impedance may be used when speakers are driven by a KA24 amplifier.

Please refer to your amplifier’s specifications to select the correct speaker impedance for your configuration.

	KA24 amp	KA84 amp	KMT sub
KP52-54 I @ 8 Ω	YES	NO	NO
KP52-54 I @ 32 Ω	NO	YES	YES
KP102-54 I @ 4 Ω	YES	NO	NO
KP102-54 I @ 16 Ω	NO	YES	YES



## 6.2 COVERAGE SWITCH

KP52-54 I and KP102-54 I feature a switch which allows users to select the vertical coverage of the speaker.

Flood coverage sets a wide vertical diffusion. Flood coverage is suggested for single speakers in diffused short throw applications to obtain maximum diffusion with a minimum footprint.

Spot coverage sets a narrower vertical diffusion angle and is recommended for long throw or monitoring application.

SPOT Coverage



FLOOD Coverage

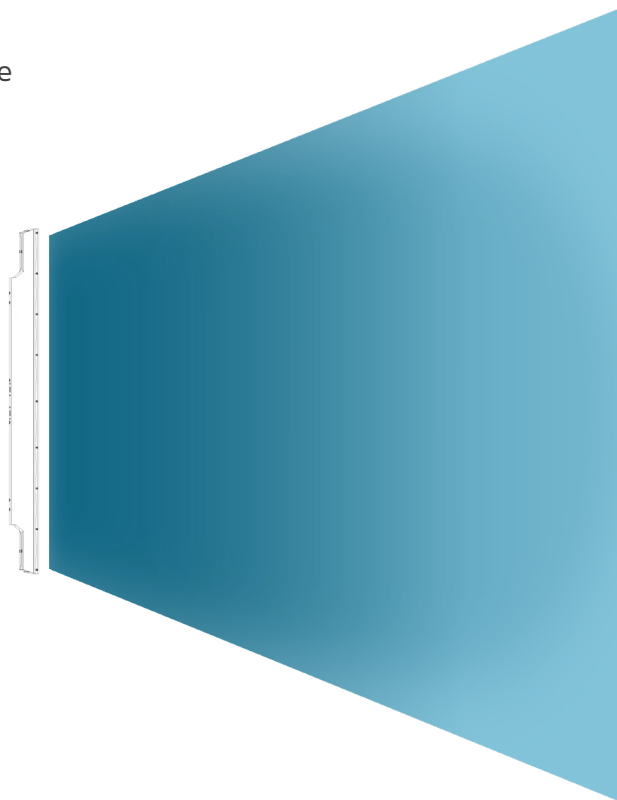

## 7. HANGING ON THE WALL

The K-WALL2 and K-WALL2L accessories are used to mount a speaker on a wall.

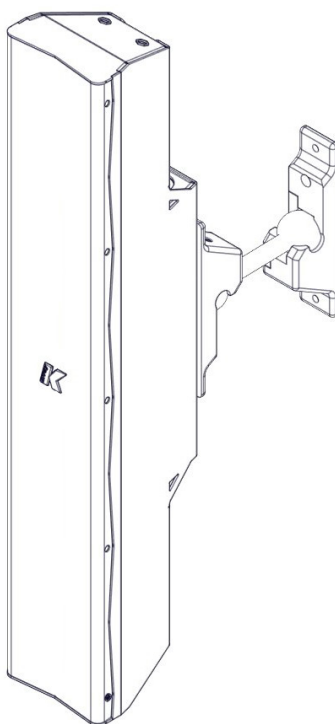

## 8. SERVICE

To obtain service:

- 1) Contact the official K-array distributor in your country. Your local distributor will direct you to the appropriate service center.
- 2) If you are calling for service, please have the serial number(s) of the unit(s) available for reference. Ask for Customer Service and be prepared to describe the problem clearly and completely.
- 3) If the problem cannot be resolved over the phone, you may be required to send the unit in for service. In this instance, you will be provided with an RA (Return Authorization) number which should be included on all shipping documents and correspondence regarding the repair. Shipping charges are the responsibility of the purchaser.

Any attempt to modify or replace components of the device will invalidate your warranty. Service must be performed by an authorized K-array service center.



### Cleaning:

Use only a soft, dry cloth to clean the product. Do not use any solvents, chemicals, or cleaning solutions containing alcohol, ammonia, or abrasives. Do not use any sprays near the product or allow liquids to spill into any openings.

## 9. TECHNICAL SPECIFICATIONS

### **KP52-54 I**

	<b>ACOUSTICS</b>
Power handling	360 W <sup>(AES)</sup>
Max power	600W
Frequency Range	100 Hz – 20 kHz (- 10dB) <sup>(1)</sup>
Impedance	8 Ω / 32 Ω (selectable)
SPL 1W/1mt	96 dB <sup>(2)</sup>
Maximum SPL	122 dB (cont.) – 128 dB (peak)
	<b>COVERAGE</b>
Horizontal	90°
Vertical	10°- 45° (selectable)
	<b>CROSSOVER</b>
Type	External Crossover required
Frequency	100 Hz, 24 dB/oct suggested minimum
	<b>TRANSDUCERS</b>
Full range	6 x 3.15" Neodymium magnet with 1" voice coil
	<b>SELECTION SWITCHES</b>
Impedance	8 Ω / 32 Ω
Coverage	Spot / Flood
	<b>POWER AUDIO INPUT</b>
Wiring	+ Red; - Black
	<b>RECOMMENDED AMPLIFIERS</b>
Type	KA24, KA84
	<b>CERTIFICATION</b>
IP	54
	<b>PHYSICAL</b>
Dimensions	8.9 x 52.0 x 11,8 cm (3.50" x 20.47" x 4.64")
Weight	5.8 kg (12.78 lbs)

### **KP102-54 I**

	<b>ACOUSTICS</b>
Power handling	720 W <sup>(AES)</sup>
Max power	1200W
Frequency Range	100 Hz – 20 kHz (- 10dB) <sup>(1)</sup>
Impedance	4 Ω / 16 Ω (selectable)
SPL 1W/1mt	99 dB <sup>(2)</sup>
Maximum SPL	128 dB (cont.) – 134 dB (peak)
	<b>COVERAGE</b>
Horizontal	90°
Vertical	7°- 30° (selectable)
	<b>CROSSOVER</b>
Type	External Crossover required
Frequency	100 Hz, 24 dB/oct suggested minimum
	<b>TRANSDUCERS</b>
Full range	12 x 3.15" Neodymium magnet with 1" voice coil
	<b>SELECTION SWITCHES</b>
Impedance	4 Ω / 16 Ω
Coverage	Spot / Flood
	<b>POWER AUDIO INPUT</b>
Wiring	+ Red; - Black
	<b>RECOMMENDED AMPLIFIERS</b>
Type	KA24, KA84
	<b>CERTIFICATION</b>
IP	54
	<b>PHYSICAL</b>
Dimensions	8.9 x 100.0 x 11,8 cm (3.5" x 39.37" x 4.64")
Weight	12.0 kg (26.5 lbs)

Notes for data

1. With dedicated preset;
2. Measured @8 mt then scaled @1 mt;
3. Measured with musical signal

New materials and design are introduced into existing products without previous notice. Present systems may differ in some respects from those presented in this catalogue.

## 10. EN54-24 DATA

KP52-54 I I and KP102-54 I I are EN54-24 compliant. Consider the specifications below when either model is used in a voice alarm system.

### ***KP52-54 I***

Power handling	360 W
SPL 1W/1m	96 dB
Maximum SPL	122 dB
Connector IN	+ Red ; - Black
Vmax In (Pink Noise)	13.40 V @ 8 Ohm 26.80 V @ 32 Ohm
Frequency Range	100 Hz - 20 kHz
Coverage Horizontal	180° @ 500 Hz
	170° @ 1000 Hz
	130° @ 2000 Hz
	120° @ 4000 Hz
Coverage Vertical	50° @ 500 Hz
	25° @ 1000 Hz
	12° @ 2000 Hz
	20° @ 4000 Hz

### ***KP102-54 I***

Power handling	720 W
SPL 1W/1m	99 dB
Maximum SPL	128 dB
Connector IN	+ Red ; - Black
Vmax In (Pink Noise)	13.40 V @ 4 Ohm 26.80 V @ 16 Ohm
Frequency Range	100 Hz - 20 kHz
Coverage Horizontal	180° @ 500 Hz
	170° @ 1000 Hz
	130° @ 2000 Hz
	120° @ 4000 Hz
Coverage Vertical	20° @ 500 Hz
	12° @ 1000 Hz
	7° @ 2000 Hz
	10° @ 4000 Hz



K-array

0068-CPR-xxx /2017

EN 54-24 : 2008

Loudspeaker for voice alarm systems for fire detection and fire alarms systems for buildings

KP52-54 I

TYPE B



K-array

0068-CPR-xxx /2017

EN 54-24 : 2008

Loudspeaker for voice alarm systems for fire detection and fire alarms systems for buildings

KP102-54 I

TYPE B